



Searches

[Part Information](#) | [Specifications](#) | [Line Drawings](#) | [Assembly Instructions](#) | [Panel Cutout](#)

Quick Search

Global Part Search **NEW!**

Global Search

Company Information

About Tuchel

Amphenol Corporate

Our Commitment

Terms & Conditions

Environmental Information

Online Catalogs

Automotive Interconnect

Industrial Connectors

Search by Family

Search by Part

Process Info Request

Download Catalog

Smart Card Connectors

Contact Information

Find a Sales Location

Distributors

Technical Support

Contact Us

Amphenol Corporation



Part Information:



Part Number: T 3363 000

Description: Female receptable, screwlocking, front mounting, solder termination, silver plating, ring nut, 5

Family: C091A

Click below to add part to your request list.
When you have finished browsing, click "Process Info Request" button.



Purchase this part



Specifications

General	Standard	Characteristics
Number of contacts		5
View on termination side of contact insert		
Contact arrangement according to DIN		-
Contact arrangement according to IEC		-
Electrical		
Rated voltage	IEC 60664-1	300 V
Rated impulse withstand voltage	IEC 60664-1	1500 V
Pollution degree	IEC 60664-1	1
Installation category	IEC 60664-1	I
Insulation group	IEC 60664-1	3
Test voltage	IEC 60664-1	908 V
Current rating	IEC 60512-3 Test 5 b	5 A / +40°C/ _104°F
Insulation resistance	IEC 60512-2 Test 3 a	>10 ¹² Ω
Contact resistance	IEC 60512-2 Test 2 a	<5 m Ω
Climatical		
Climatic category	IEC 60068-1	40 / 85 / 56
Temperature range	IEC 60068-1	-40°C ... +85°C/-40°F ... +185°F
Mechanical		
IP-degree	IEC 60529	IP 40
Insertion and withdrawal forces	IEC 60512-7 Test 13 b	35 N 125.oz
Mechanical operation	IEC 60512-5 Test 9 a	Silver ≥ 500 mating cycles Gold ≥ 1000 mating cycles
Materials		
Housing		die cast, nickel plated
Dielectric		thermoplastic
Contact plating		silver plated, gold plated
Other Characteristics		

Termination technique		solder, crimp
Wire gauge		solder $\leq 0.5\text{mm}^2$ (20-26 AWG) crimp $0.14\text{-}1.0\text{mm}^2$ (26-18 AWG)
Flammability		UL 94 VO
Locking system	IEC 103-9	metal screw coupling



Line Drawings

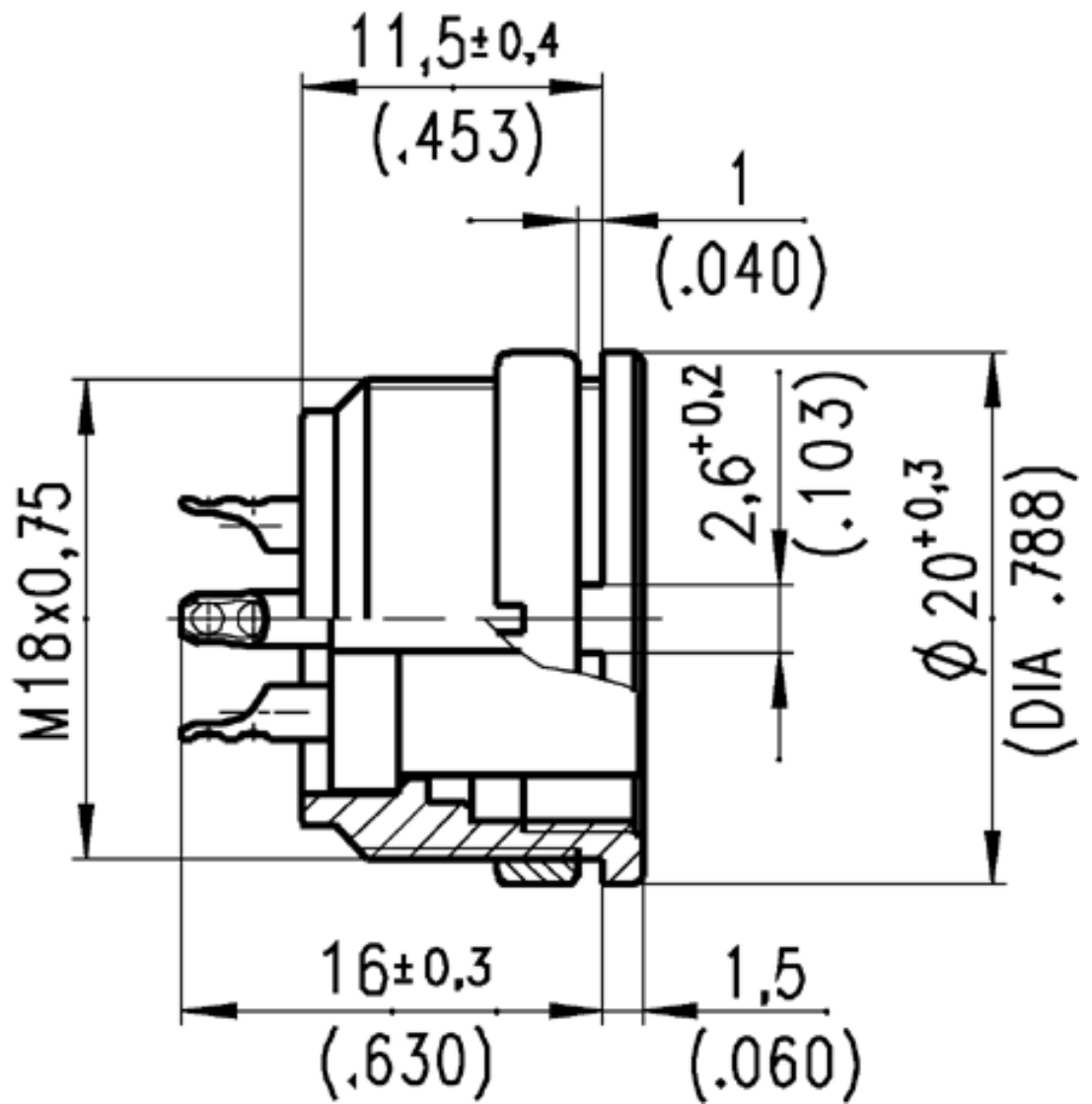

Panel Cutout

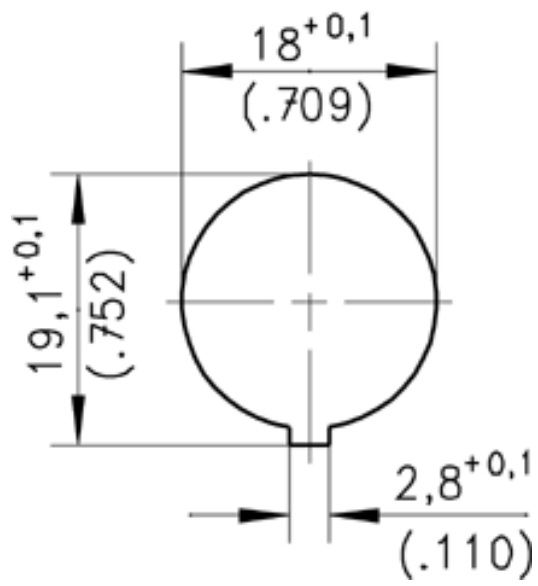

 **Assembly Instructions**

